

Power Window

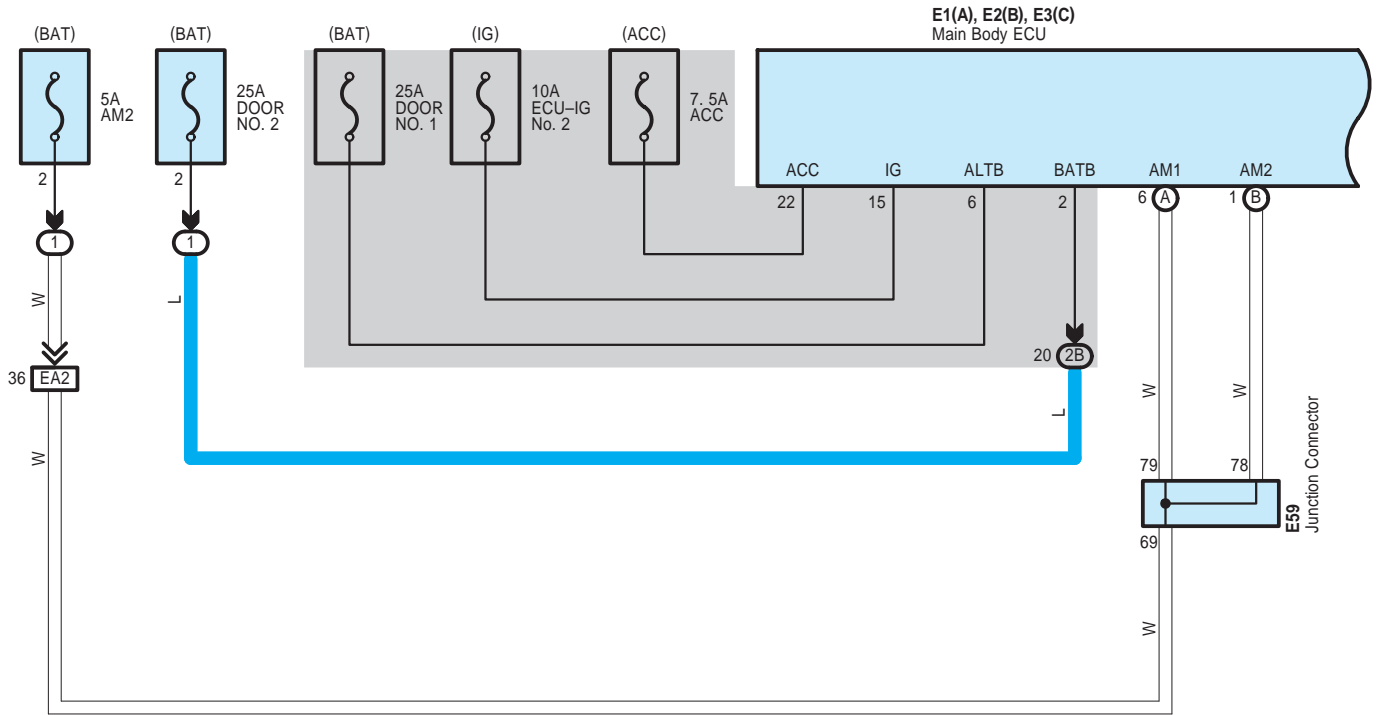

E1(A), E2(B), E3(C)
Main Body ECU

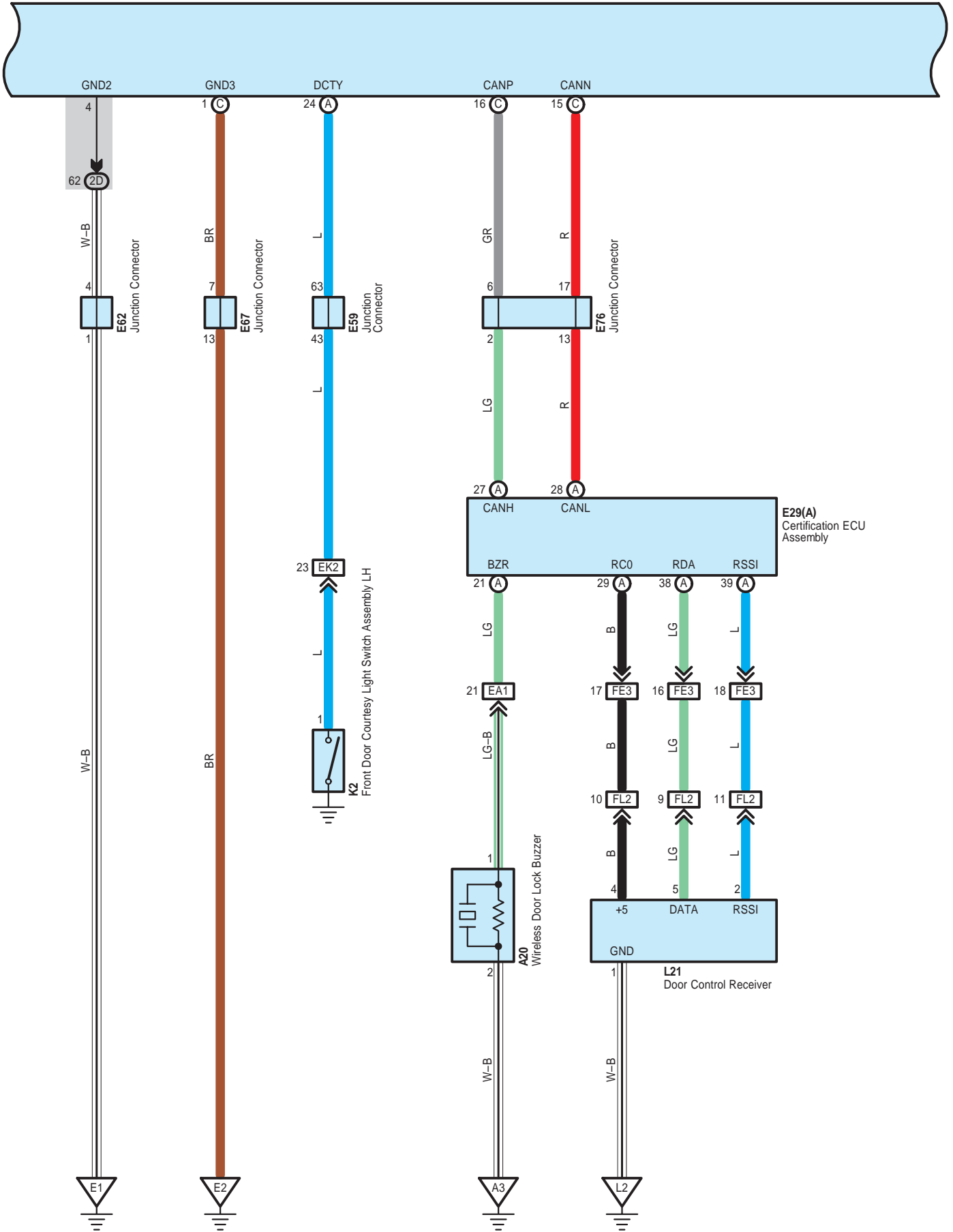

Power Window

E1(A), E2(B), E3(C)
Main Body ECU

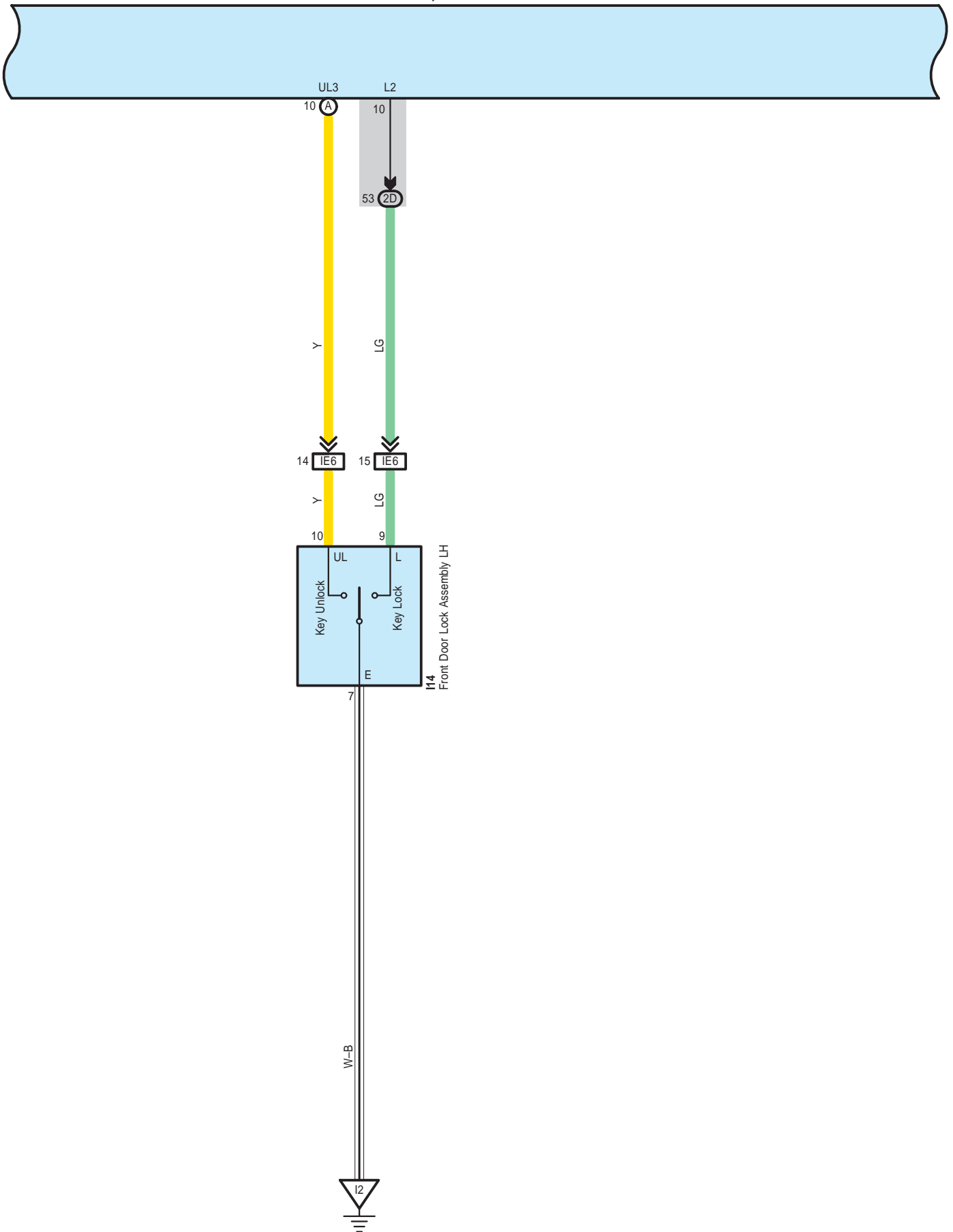

Power Window

E1(A), E2(B), E3(C)
Main Body ECU

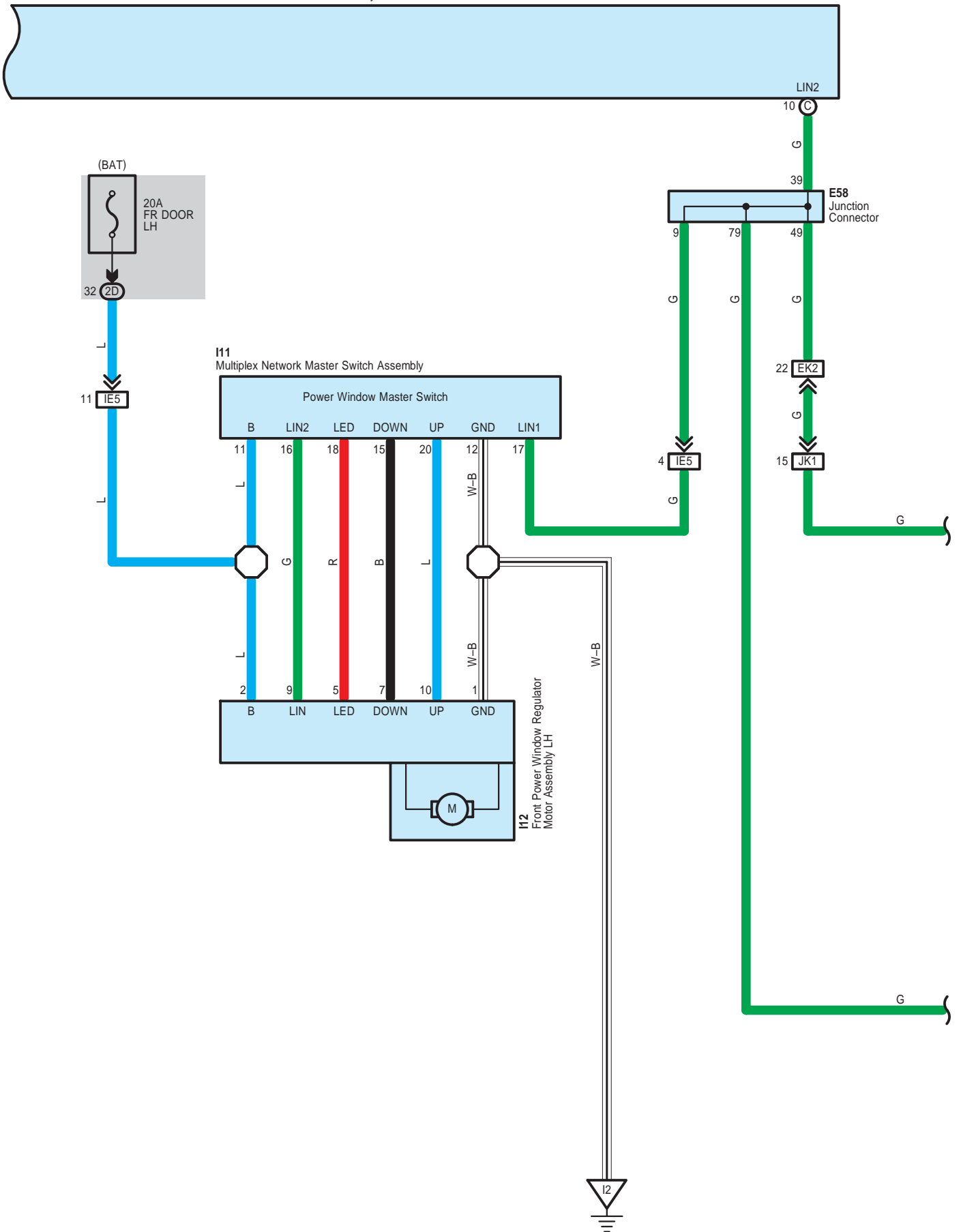

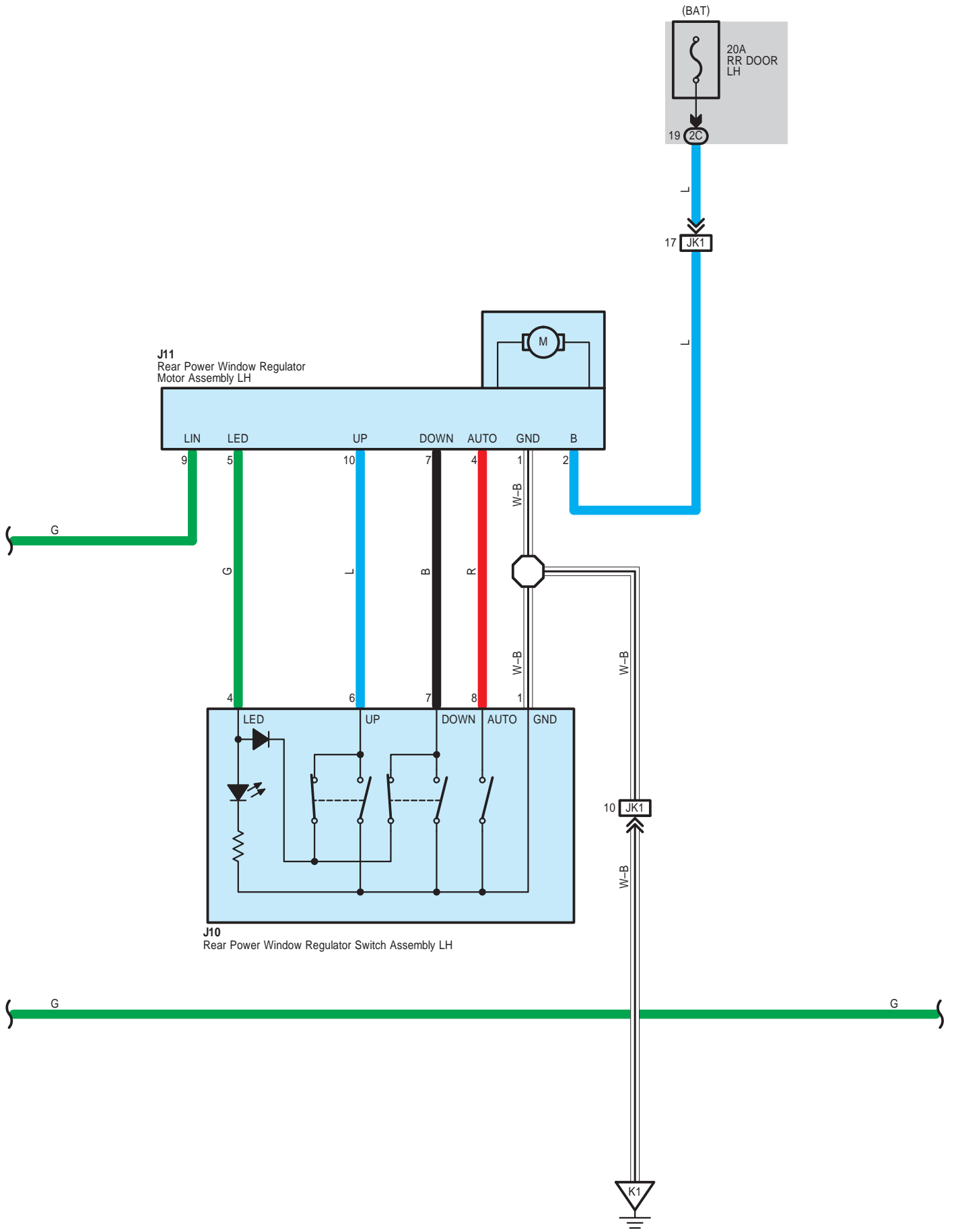

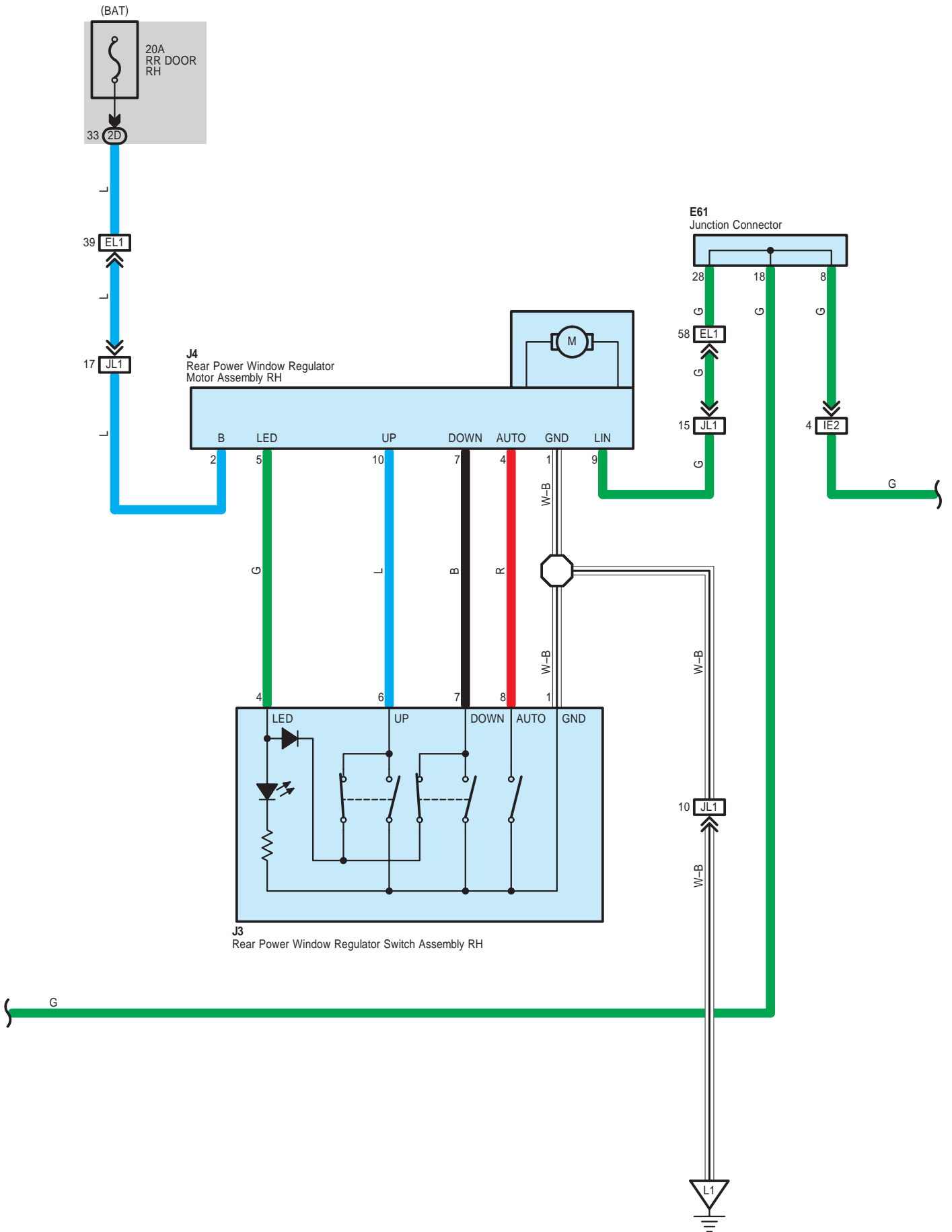

Power Window

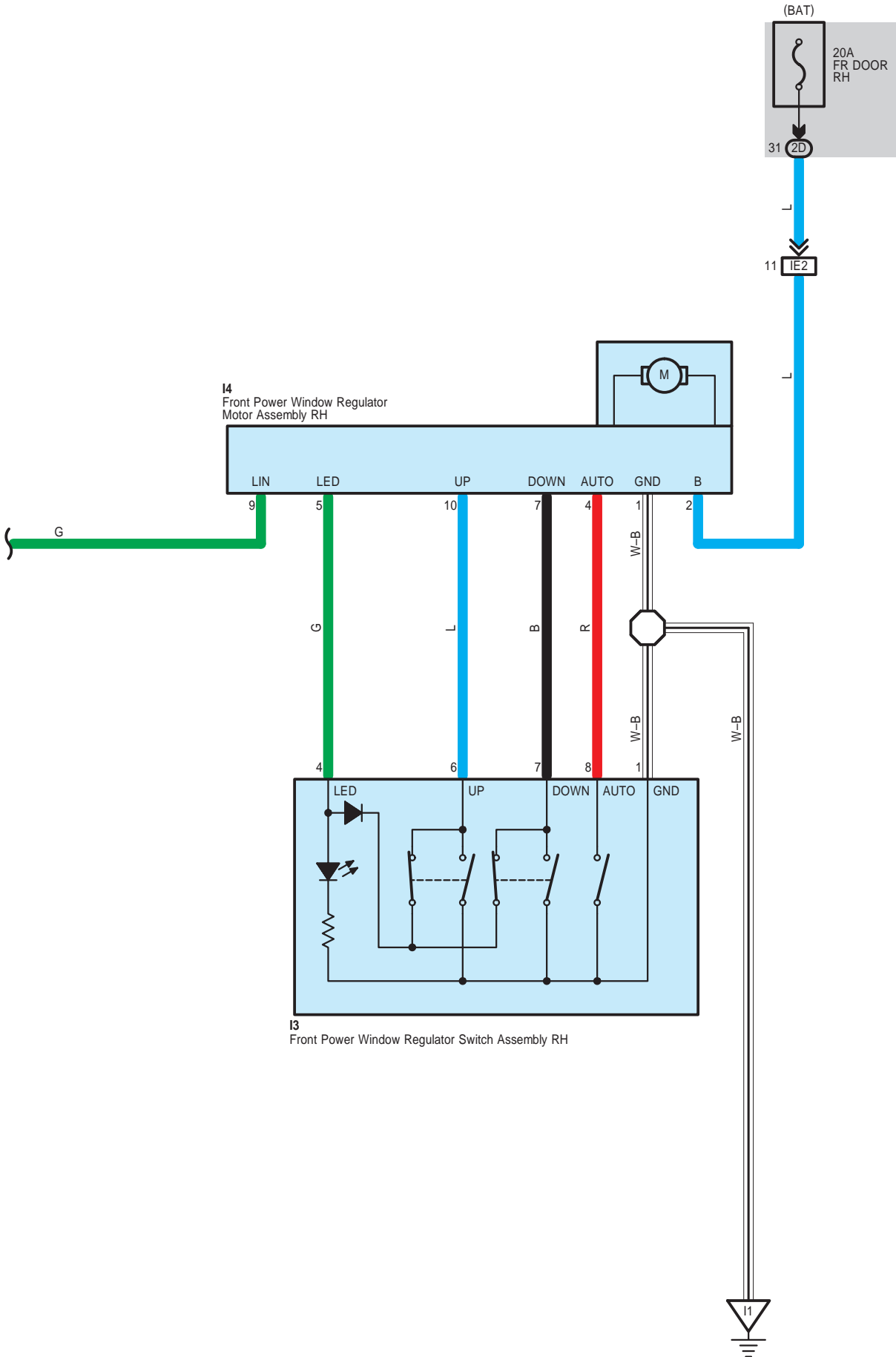

Power Window

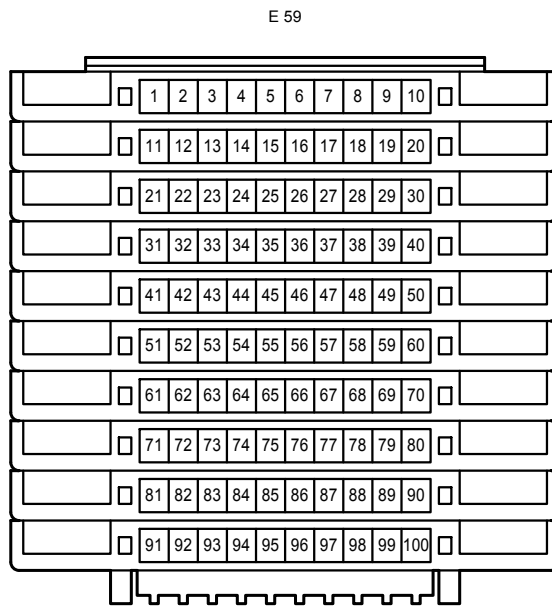
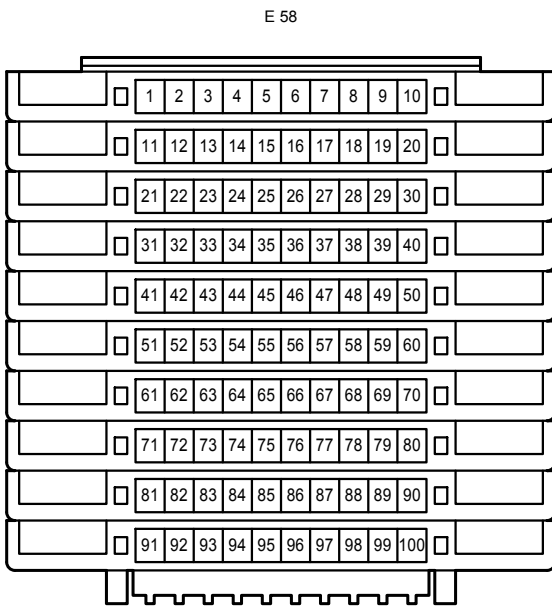
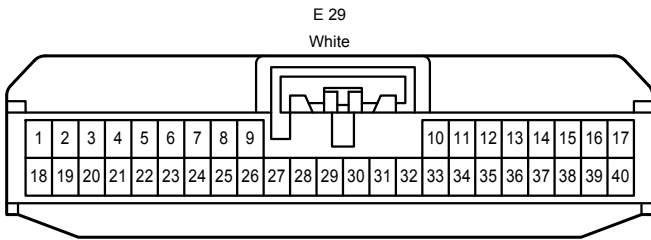
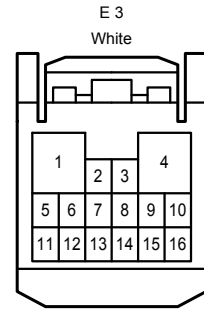
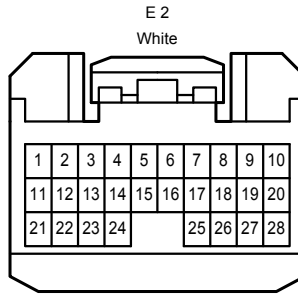
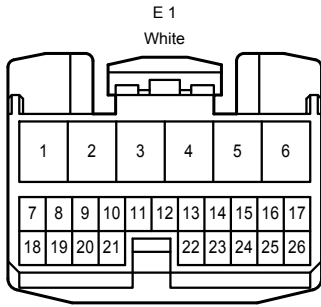
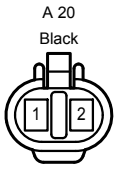

Power Window

E 61

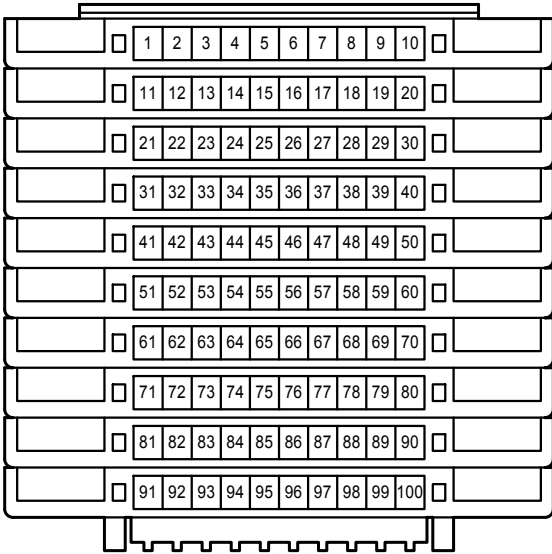

E 62

White

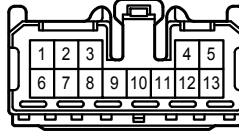

E 67

White

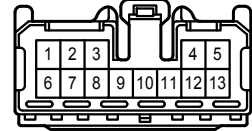

E 76

Gray

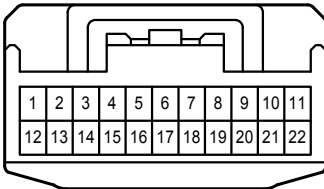

I 3

White

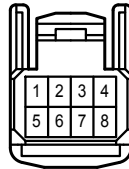

I 4

White

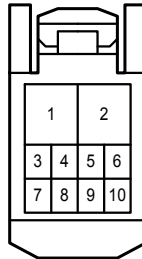

I 11

White

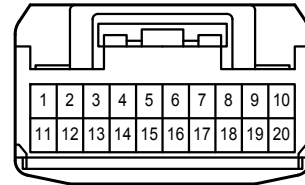

I 12

White

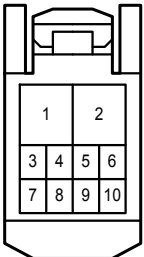

I 14

White

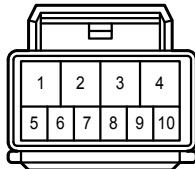

J 3

White

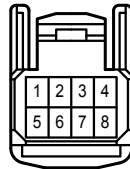

J 4

White

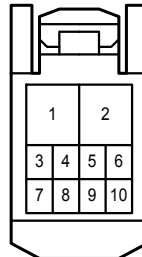

J 10

White

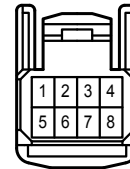

J 11

White

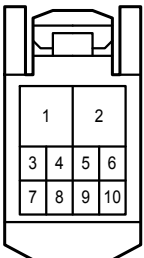

K 2

White



L 21

White

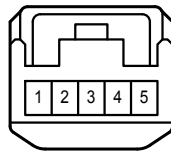

2B

White

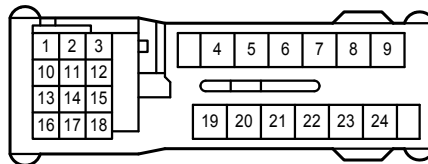

Power Window

2C
White

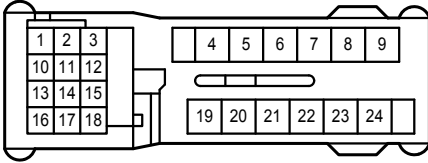

2D
White

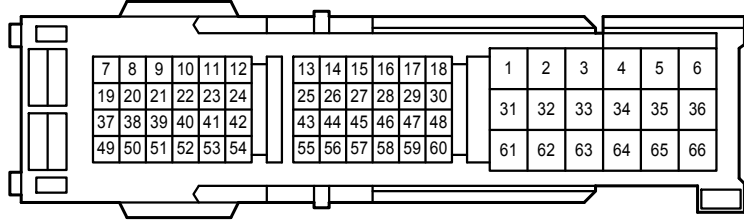

EA1
White

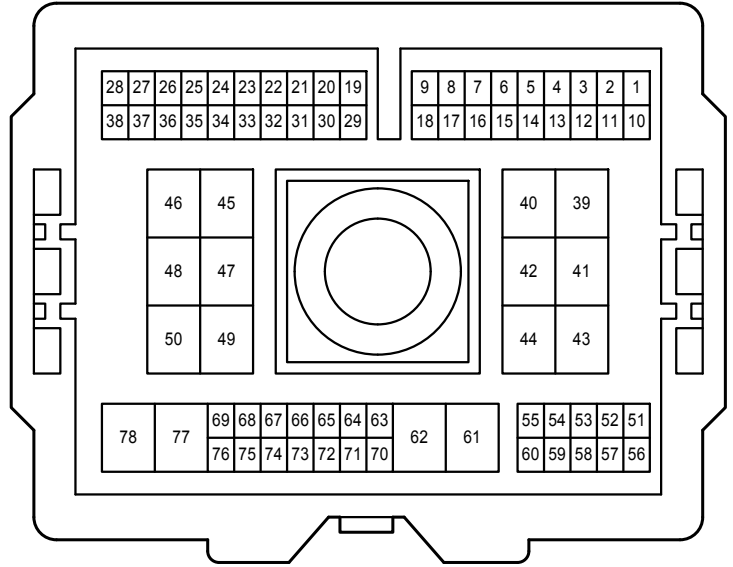
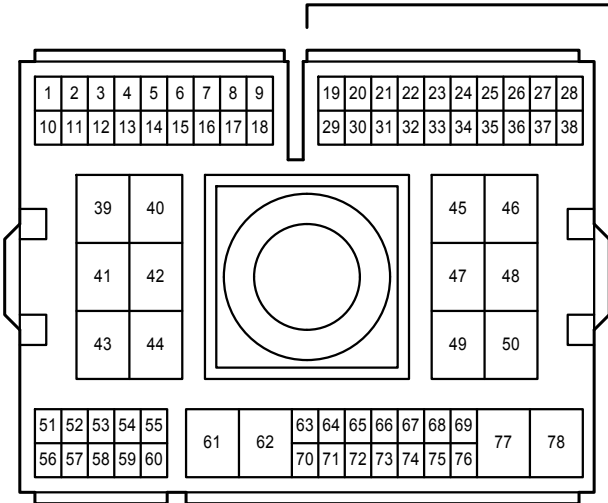

EA2

White

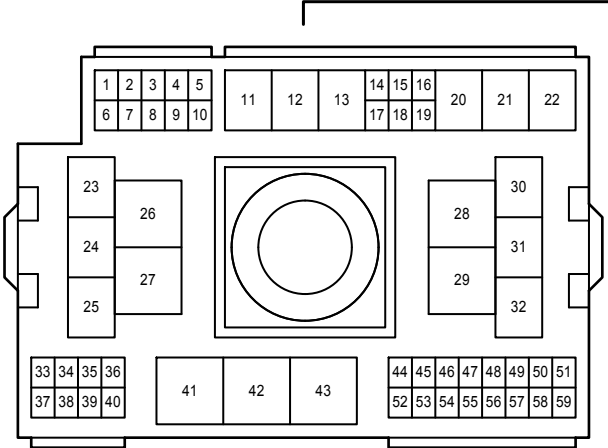

Gray

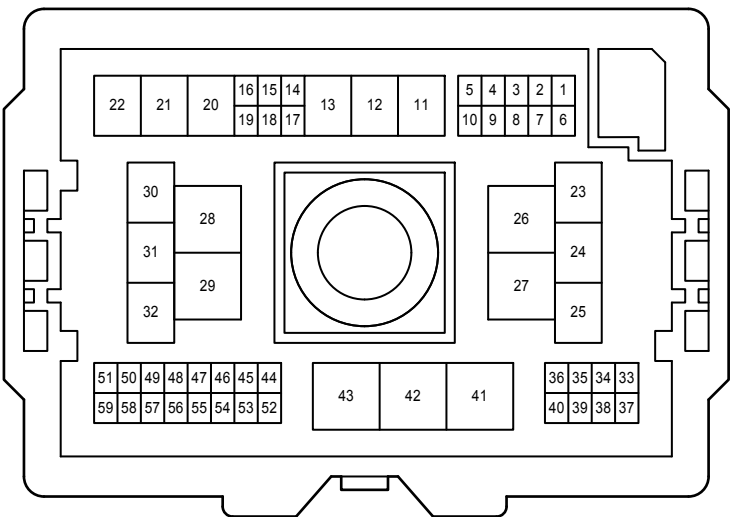

Power Window

EK2
White

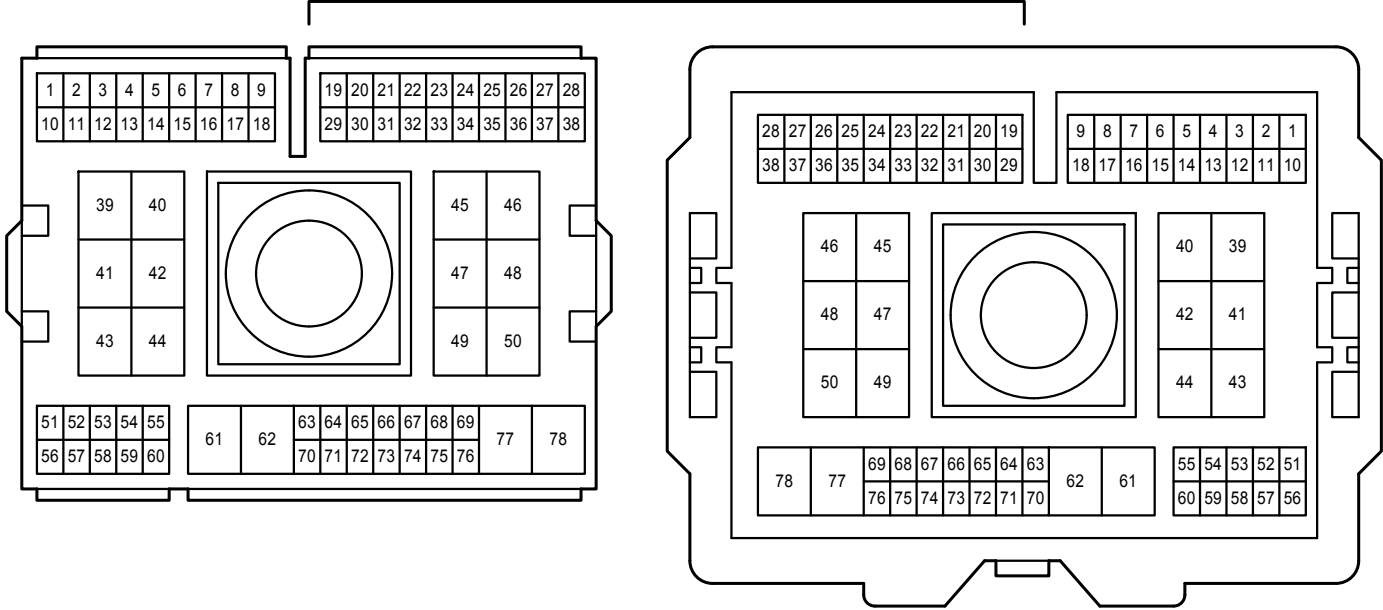

EL1
White

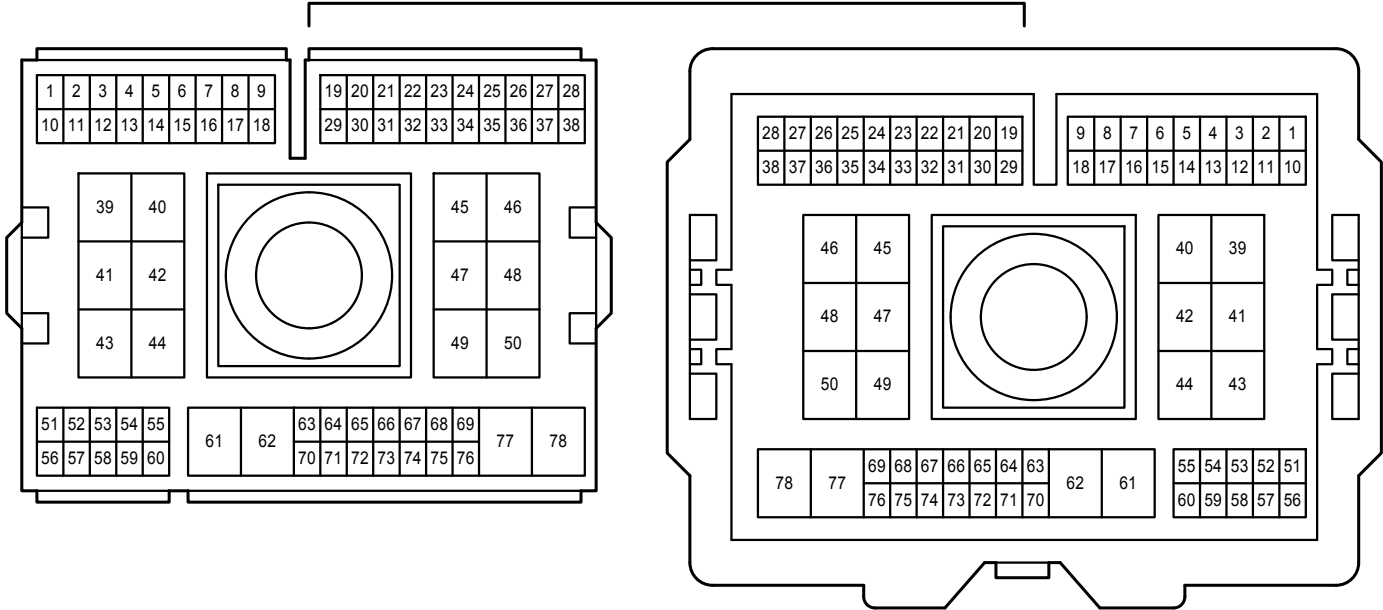

FE3
White

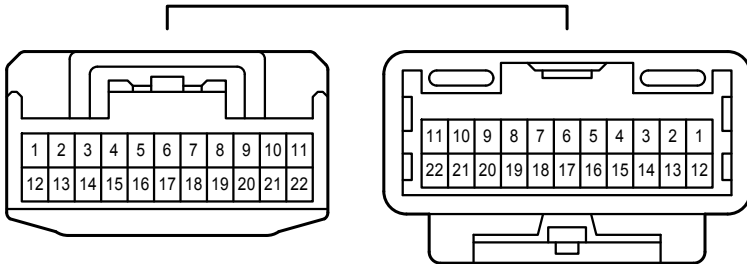

FL2
Blue

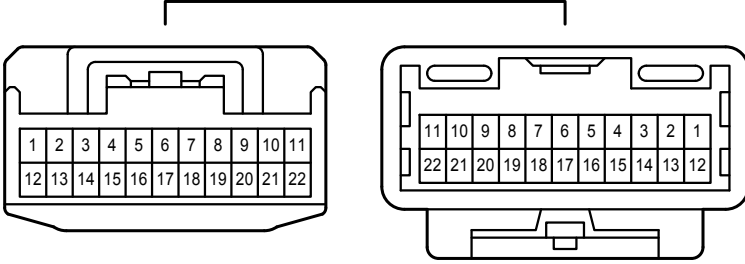

IE2
Blue

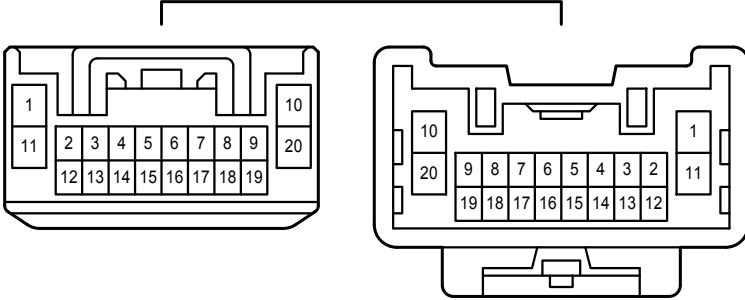

IE5
Blue

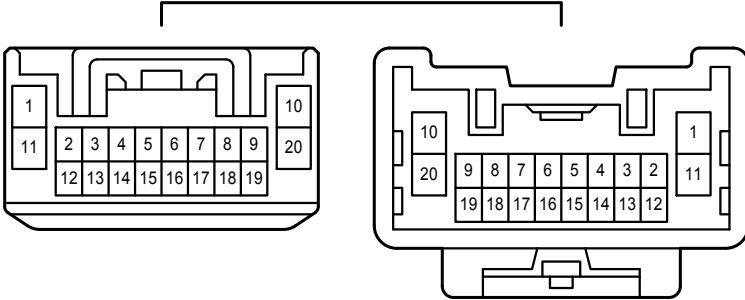

IE6
White

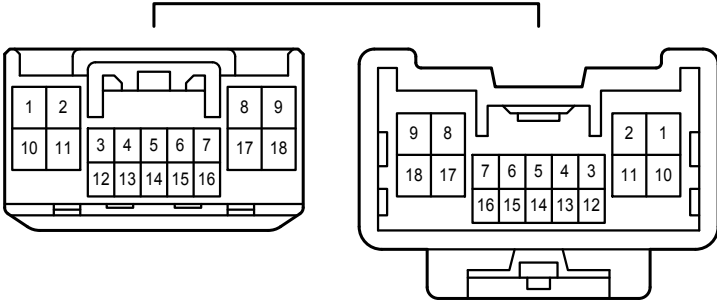

JK1
White

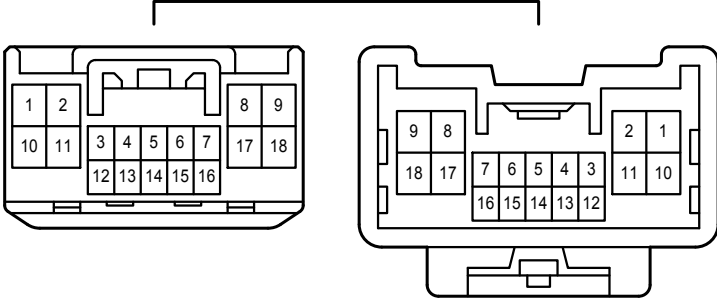

JL1
White

